

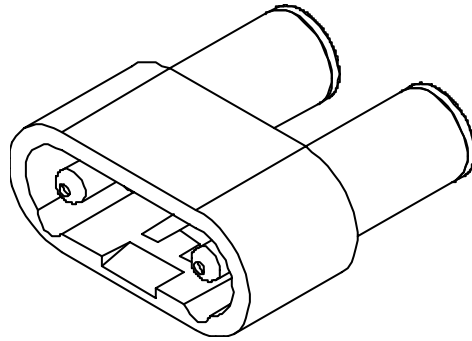

UL Recognized Plug Polarized for 24 Volts



Part #:	KS21103L3
Certifications:	UL Recognized Plug Meets requirements of RoHS Directive 2002/95/EC
Flammability: Rating	UL 94V0
Mass:	22.7 grams
Oxygen Index:	35 %
Polymer %:	70.0%
Housing:	Lexan® 940 (polycarbonate)
Contacts:	Tin Plated Copper